



SEIFOMAT[®]
SEIFENSPENDER

CATALOGUE

WASHBASIN FITTINGS

Single-Handle Faucet



Order No.

10150002

Typ

Pure Single-Handle Faucet
with clickclack-valve



Bestell-Nr.

10150003

Typ

Pure Exquisit Single-Handle Faucet
with click-clack-valve



Bestell-Nr.

10150001

Typ

Square Single-Handle Faucet
with click-clack-valve



WASHBASIN SOAP DISPENSER

Seifomat® Pure



Order No.	12080511
Type	Seifomat® Pure *
Label	SPC3
Outlet in mm	95 x 18



Order No.	12080512
Type	Seifomat® Pure Steel *
Label	SPS3
Outlet in mm	95 x 18



Order No.	12080514
Type	Seifomat® Pure Slim *
Label	SP3S
Outlet in mm	90 x 9

Seifomat® Square



Order No.	12080318
Type	Seifomat® Square *
Label	SF318
Outlet in mm	80 cornered

* Please order containers separately.



Seifomat Nova®



Order No. 12080201
Type Seifomat Nova® *
Label SN30
Outlet in mm 90 x 9



Order No. 12080207
Type Seifomat Nova® *
Label SN50
Outlet in mm 130 x 9



Order No. 12080230
Type Seifomat Nova KIGA® *
Label KIGA
Outlet in mm 90 x 9



Order No. 12080212
Type Seifomat Nova Steel®
 (Stainless steel 316) *
Label ST30
Outlet in mm 90 x 10

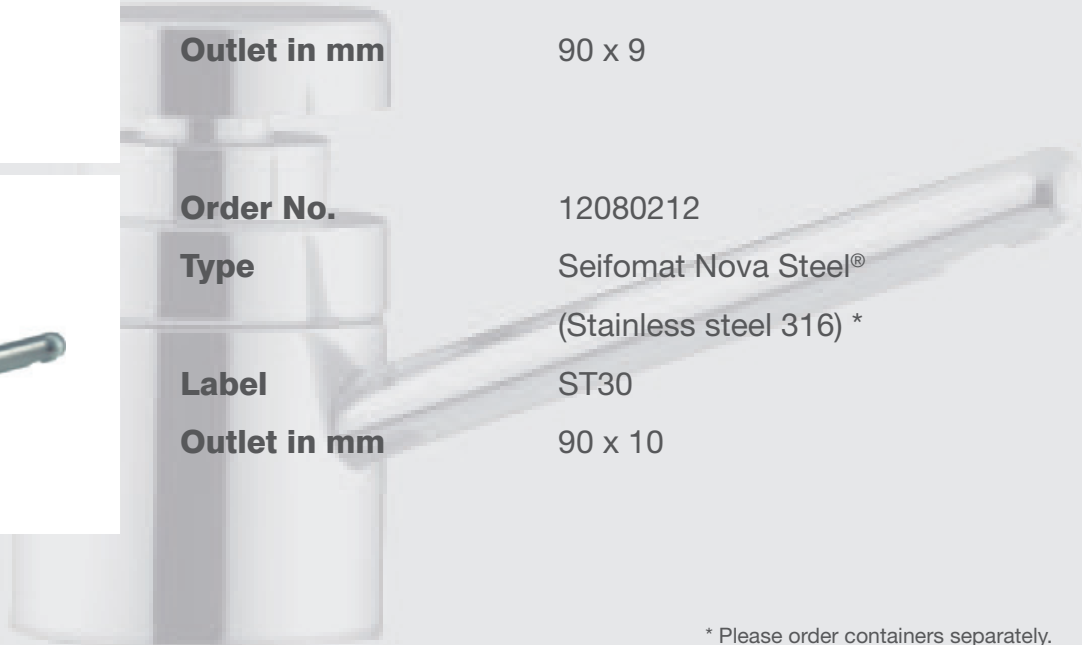

* Please order containers separately.

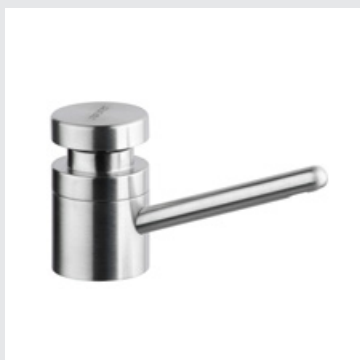

Order No. 12080211
Type Seifomat Nova Steel®/2
(Stainless Steel 316) *
Label ST30/2
Outlet in mm 90 x 10



Order No. 12080223
Type Seifomat Nova® Exquisit *
Label SN323
Outlet in mm 130 x 9

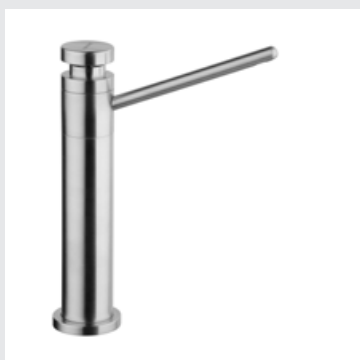

Order No. 12080214
Type Seifomat Nova Steel®/2 Exquisit
(Stainless steel 316) *
Label ST323
Outlet in mm 130 x 10

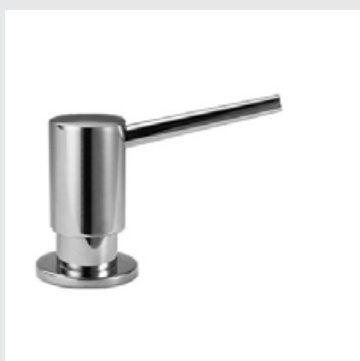

Order No. 12080121
Type Seifomat Nova Piccolo® 71 *
Label SD 71 K
Outlet in mm 70 x 7

(suitable for domestic use and disinfectants)

* Please order containers separately.

Seifomat Safe®

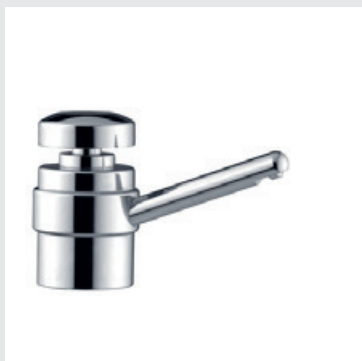

Order No.	12080701
Type	Seifomat Safe Frankfurt® *
Label	SF50
Outlet in mm	95 x 12

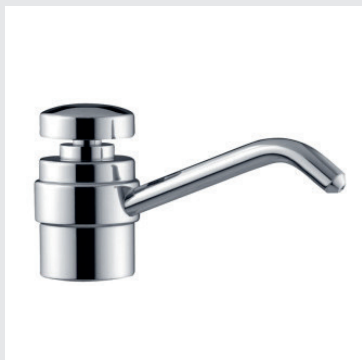

Order No.	12080601
Type	Seifomat Safe® *
Label	SF51
Outlet in mm	130 crooked

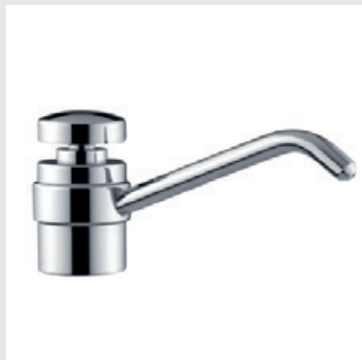

Order No.	12080617
Typ	Seifomat Safe® *
Label	SF52
Outlet in mm	200 crooked

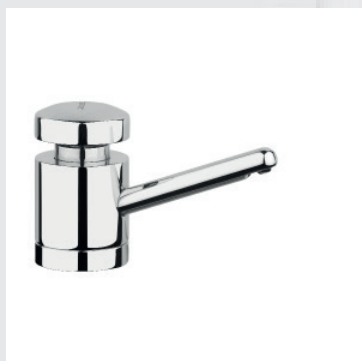

Order No.	12080801
Type	Seifomat Super Safe® *
Label	SF60
Outlet in mm	90 x 12

* Please order containers separately.

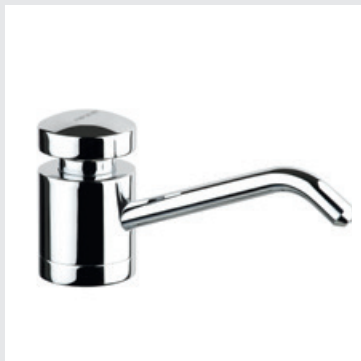

Outlet No. 12080802
Type Seifomat Super Safe® 130 *
Label SF63
Outlet in mm 130 crooked

Seifomat de Luxe®



Order No. 12080301
Type Seifomat de Luxe® *
Label SL10
Outlet in mm Cast spout 90

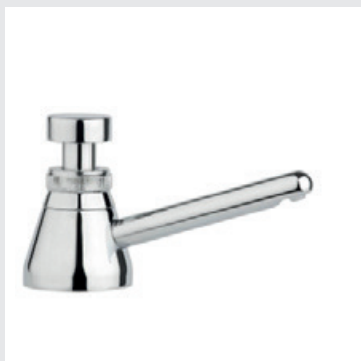

Order No. 12080401
Type Seifomat de Luxe® *
Label SL20
Outlet in mm 90 x 12

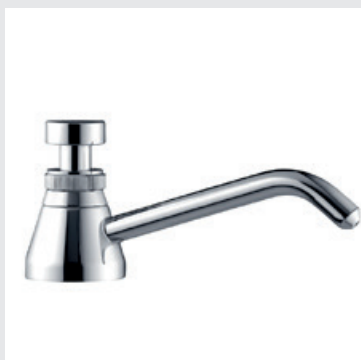

Order No. 12080421
Type Seifomat de Luxe® *
Label SL21
Outlet in mm 130 crooked



* Please order containers separately.



Seifomat® Trend



Order No.	12750001
Type	Seifomat® Trend *
Label	SSTC
Outlet in mm	90 x 9



Order No.	12750002
Type	Seifomat® Trend Steel *
Label	SSTS
Outlet in mm	90 x 10

Seifomat Air & Ship®



Order No.	12080140
Type	Seifomat Air & Ship® *
Label	AS
Outlet in mm	90 x 9



* Please order containers separately.

Seifomat Universal®

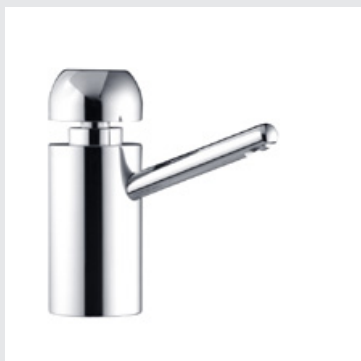

Order No. 12404011
Type Seifomat Universal® Knopf Halbrund *
Label 404/01/10
Outlet in mm 90 x 12

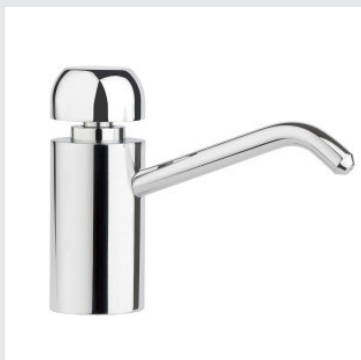

Outlet No. 12404012
Type Seifomat Universal® Knopf Halbrund *
Label 404/01/13
Outlet in mm 130 gebogen

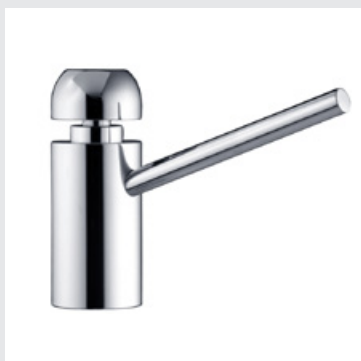

Outlet No. 12404014
Type Seifomat Universal® Knopf Halbrund *
Label 404/01/15
Outlet in mm 150 x 12

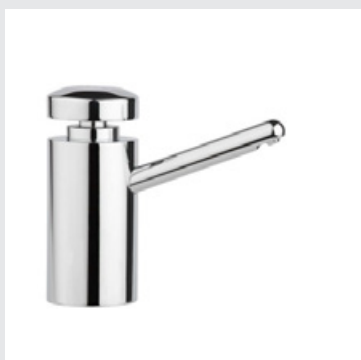

Order No. 12404021
Type Seifomat Universal® Knopf Safe *
Label 404/02/10
Outlet in mm 90 x 12

* Please order containers separately.



Order No. 12404022
Type Seifomat Universal® Knopf Safe *
Label 404/02/13
Outlet in mm 130 crooked



Order No. 12404024
Type Seifomat Universal® Knopf Safe *
Label 404/02/15
Outlet in mm 150 x 12



Order No. 12404031
Type Seifomat Universal® Knopf Exquisit *
Label 404/03/10
Outlet in mm 90 x 12



Outlet No. 12404032
Type Seifomat Universal® Knopf Exquisit *
Label 404/03/13
Outlet in mm 130 crooked

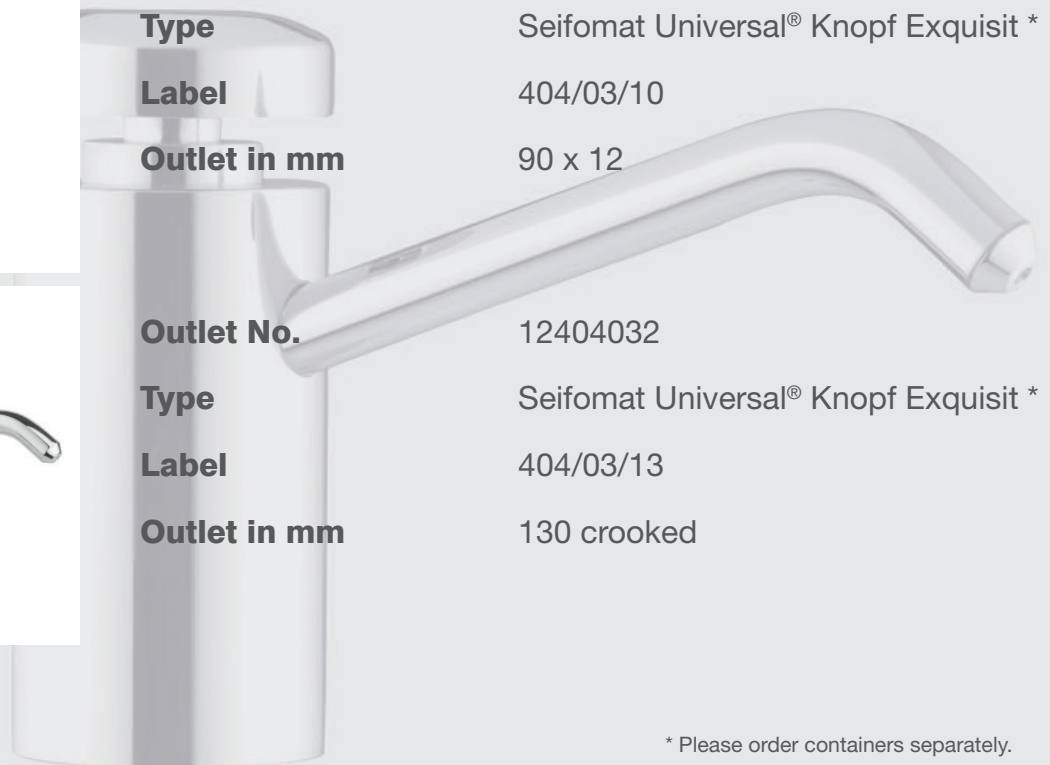

* Please order containers separately.



Seifomat Exquisit®

Order No. 12404034
Type Seifomat Universal® Knopf Exquisit *
Label 404/03/15
Outlet in mm 150 x 12

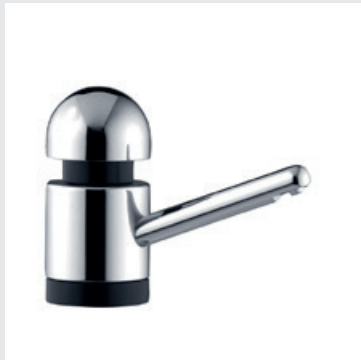

Order No. 12080901
Type Seifomat Exquisit® *
Label S310
Outlet in mm 90 x 12

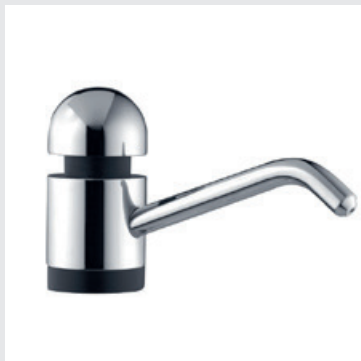

Order No. 12080930
Type Seifomat Exquisit® *
Label S313
Outlet in mm 130 crooked



Order No. 12080323
Type Seifomat Exquisit® (Höhe 220 mm) *
Label S323
Outlet in mm 150 x 12



* Please order containers separately.



Order No.	12080327
Type	Seifomat Exquisit® (height 260 mm) *
Label	S327
Outlet in mm	150 x 12



All washbasin soap dispensers are delivered without a soap container. These must be ordered additionally. When ordering soap dispensers, please enclose the desired container size. See accessories.

* Please order containers separately.

Seifomat® Wall soap dispenser

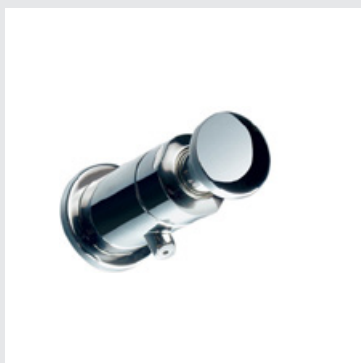

Order No.	12080150
Type	Seifomat Air & Ship® Wall model, Pressure *
Label	AS W D, Soap dispenser valve

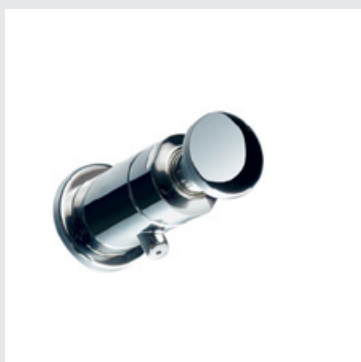

Order No.	12080155
Type	Seifomat Air & Ship® Wall model, suction *
Label	AS W A, Soap dispenser valve



Order No.	12080292
Type	Seifomat® VARIS for corner installation approx. 450 ml *
Label	VARIS E, Wall soap dispenser



Order No.	12080293
Type	Seifomat® VARIS for the wall approx. 450 ml *
Label	VARIS W, Wall soap dispenser

* Please order containers separately.



ACCESSORIES

Container for soap dispenser

Order No.	Type	Label
14635600	Container 250 ml	F 025
14635611	Container 500 ml	F 050
14635633	Container 1.000 ml	F 100
14635400	Container 250 ml, with valve	MF 025
14635411	Container 500 ml, with valve	MF 050
14635433	Container 1.000 ml, with valve	MF 100
14635511	Stainless steel container 450 ml, with screwcap	EF 045

Order No.	Type	Label
12080222		1/2" x Ø 50 Chrom US
50		
12080224	Washer 1/2" x Ø 60 Chrome	US 60
12080225	Washer 1/2" x Ø 50 Stainless steel	US 50 M

Order No.	Type	Lable
15999903	Filling funnel for 5kg / 10kg canister	
14635807	Filling funnel with ventilation ribs	FT
14639965	Central supply for 2. Seifomat (supply line)	
14663623	Fixing for 5 litze-container (stainless steel)	

When equipping several soap dispensers with a central supply, only original Seifomat® parts may be used. If self-designed central supplies are used, the guarantee does not apply in the event of malfunctions. Please also observe the installation and commissioning instructions as well as the refilling instructions. All parts subject to normal wear and tear (O-rings, diaphragms, key seals) are excluded from warranty coverage.

SEIFEN



Order No.	Type	Label
15999911	Liquid soap for Seifomat soap dispenser 0,5 ltr. bottle	SC050
15999901	Liquid soap for Seifomat soap dispenser 1,0 ltr. bottle	SC100
15999904	Liquid soap for Seifomat soap dispenser 5,0 ltr. canister	SC500
15999907	Liquid soap for Seifomat soap dispenser 10 ltr. canister	SC1000

seifomild[®]
Seifencreme für Seifomat Seifenspender

Soap: Only use liquid cream soap, detergent, shampoo, etc. for private use (so no industrial soap). We recommend our soap cream Seifomild®; this soap cream is specially designed for use in soap dispensers. It is subtly perfumed with a pleasant fragrance, dermatologically tested, free of sodium chloride, is cosmetically mild for the skin, DIN tested and biodegradable.

Note: Especially industrial hand cleaners, natural (organic) liquid soaps and agents with a high Content of disinfecting components can lead to faster wear of the pump mechanism. The cleaning product must under no circumstances contain abrasives and/or solvents. If in doubt, consult the supplier of the cleaning product.

Global guidelines for liquid soaps, etc.:

pH	: 6 - 7,5	Complex images
Perfums	: < 1%	(EDTA, NTA)
vegetable oils	: < 1%	Optimal
animal fats	: < 1%	Viscosity (20°) : 700 -3000 mPa·s
		Seifomild soap: 1500-2000 mPa·s

SPARES



Order No.

Type

14279957	Revision rate 12 pcs. (02, 03, 04, 06, 07, 09, 10, 11, 12, 13, 14, 15)
14279981	Revision rate KIGA 12 pcs. (02, 03, 04, 06, 07, 09, 10, 11, 12, 13, 14, 15)
14279990	Revision rate Steel 12 pcs. (02, 03, 04, 06, 07, 09, 10, 11, 12, 13, 14, 15)
14279968	Revision rate 8 pcs. (03, 04, 06, 07, 10, 11, 12, 13)
14279970	Revision rate Trend
12089301	Interior set for Seifomat de Luxe®
12089601	Interior set for Seifomat Safe®, Super Safe®, Universal® Knopf Safe
12089201	Interior set for Seifomat Nova®
12089230	Interior set for Seifomat Nova KIGA®
12089223	Interior set for Seifomat Nova® SN323
12089212	Interior set for Seifomat Nova Steel®, Pure Steel
12089211	Interior set for Seifomat Nova Steel/2®
12089214	Interior set for Seifomat Nova Steel/2® ST323
12089901	Interior set for Seifomat Exquisit® 310/313/323/327, Universal® Knopf Rund
12089902	Interior set for Seifomat Universal® Knopf Halbrund
12089511	Interior set for Seifomat® Pure
12089514	Interior set for Seifomat® Pure Slim
12089318	Interior set for Seifomat® Square
12089120	Interior set for Seifomat SD 71 K® ohne Kopf
12089140	Interior set for Air and Ship® Wandmodell Ansaugend
12089141	Interior set for Air and Ship® Wandmodell Druck
12089291	Interior set for Varis®
12089142	Interior set for Air and Ship® Standmodell

SPARES

Order No.	Type
12759001	Pump head Seifomat® Trend
12759002	Pump head Seifomat® Trend Steel
14637016	Press button Nova, Pure
14607020	Press button Nova Steel, Nova Steel/2, Pure Steel
14637013	Press button Nova KIGA
14661437	Press button de Luxe
14637017	Press button Safe
14636014	Press button Exquisit
14637015	Press button Universal Halbrund
14637014	Press button Pure Slim
14637020	Press button Air und Ship
14607021	Press button Square
14635092	Bottle nur with membrane
14636236	Outlet nozzle for Seifomat de Luxe
14636050	Line per 100 cm
14636000	hex driver3 mm
14600000	Mounting kit: bottle nut with membrane, counter nut, sealing ring
12080294	Attachment f. VARIS Corner BVE
12080295	Attachment f. VARIS Wall BVW
12080297	Plastic lid black for Varis



From 500,00 € net value of goods the delivery is post-paid. For special models or special colors, we cannot accept order cancellation or later return. In all other respects, the general terms and conditions of delivery and payment of Fritz Ostermann GmbH shall apply. Changes and errors excepted.

All prices printed in this price list are net prices and are exclusive of VAT.



EXPLODED DIAGRAM

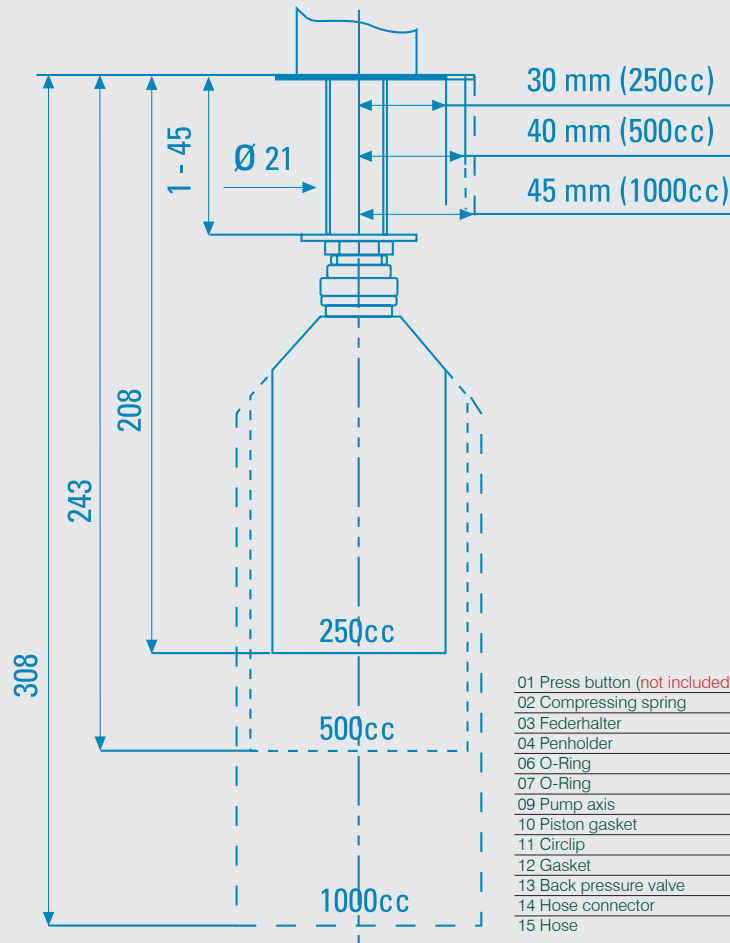

	Revision rate 8-part	Revision rate 12-part
01 Press button (not included in the revision rate)		
02 Compressing spring		●
03 Federhalter	●	●
04 Penholder	●	●
06 O-Ring	●	●
07 O-Ring	●	●
09 Pump axis	●	●
10 Piston gasket	●	●
11 Circlip	●	●
12 Gasket	●	●
13 Back pressure valve	●	●
14 Hose connector		●
15 Hose		●

Exploded view of an interior set

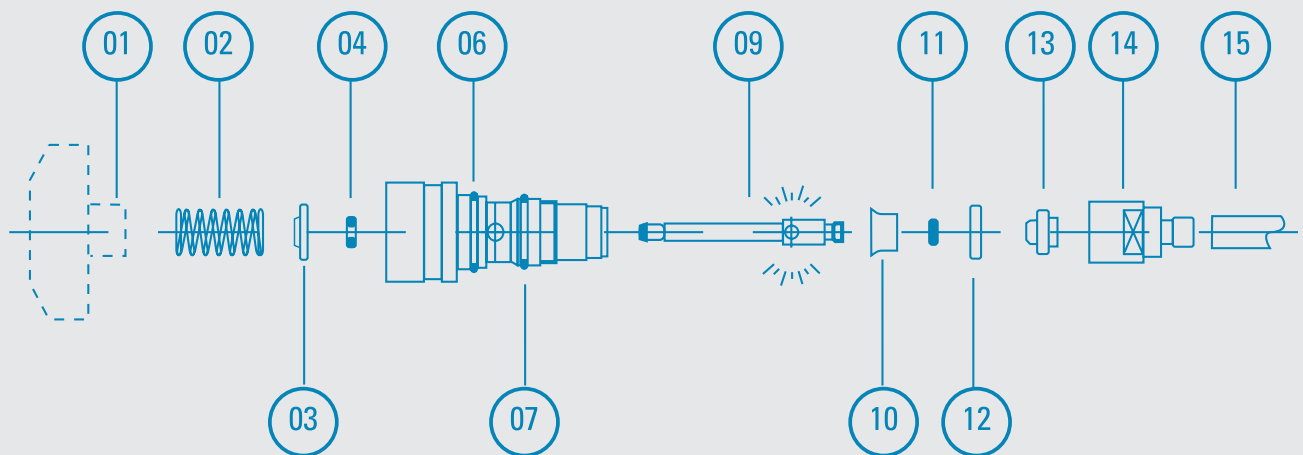

SPECIFICATIONS Seifomat® Soap dispenser

Model	de Luxe SL 10	de Luxe SL 20 SL 21	Safe SF 50 SF 51 SF 52	Exquisit S 310 S 323 S 313 S 327*		Nova Pic. SD 71 K	Nova SN 30 ST 30 KIGA SN 50 SN323* ST323*	Super Safe SF 60 SF 63	Air & Ship	Square	Pure SPC 3 SPS 3 SP3 S*	Universal 404/01/... 404/02/... 404/03/...	Trend SSTC SSTS
Height in mm	62	68	80	90	220	66	62	75	69	110	102	01*115 02*105 03*120	85
Diameter of the press button in mm	27	27	45	45	45	30	38	45	25	30	38 32*	45	30
Diameter of the carcass in mm	43	43	49	45	45	50	38	45	32	30	38 32*	45	30
Weight ca.	0,5 kg	0,5 kg	1,1 kg	0,9 kg	1,9 kg 2,5 kg*	0,3 kg	0,5 kg 1,4 kg*	0,9 kg	0,35 kg	0,9 kg	0,9 kg 0,7 kg*	01*1,19 kg 02*1,15 kg 03*1,22 kg	0,5 kg
Maximum work surface strength in mm	30	40	40	40	40	30	40	40	40	40	40	40	40
Hole bore in mm	21 - 32	21 - 32	21 - 32	21 - 32	21 - 32	21 - 32	21 - 32	21 - 32	21 - 27	21 - 27	21 - 32	21 - 32	21 - 32
Underrun Nosing													
70 mm													
90 mm	●	●	●	●			●	●	●	●	●*	●	●
100 mm											●		
130 mm		●	●	●			●	●				●	
150 mm					●								
200 mm			●									●	
Special lengths by inquiry		●	●	●			●	●	●		●		●
Shaft thread 1/2"AG	●	●	●	●	●	●	●	●	●	●	●	●	●



Fritz Ostermann GmbH

Gottlieb-Daimler Str. 24
59439 Holzwickede

Fon +49 (0) 2301-91940-0
Fax +49 (0) 2301-91940-20

Monday to Thursday:
7.30 bis 16.00 Uhr
Friday:
7.30 bis 13.00 Uhr

info@seifomat.de
www.seifomat.de



III. Einhebelmischer Pure
mit Seifomat® Pure Slim