

UNIVERSAL  
KNOPF  
EXQUISIT  
404/03/10  
Item No. 12404031

SEIFOMAT®  
SEIFENSPENDER

## PRODUCT FEATURES

Table soap dispenser brass chromium plated,  
solid reciprocating piston pump

- outlet: 90 mm
- bore diameter: 21-28 mm
- brass chromium plated
- for the installation in washing stands
- to be filled from the top
- burglar-proof due to hexagon socket screw

### Accessories:

- liquid soap Seifomild Zero®  
0,5 ltrs. / 1 ltrs. / 5 ltrs. / 10 ltrs.  
(microplastic-free, chlorine-free,  
dermatologically tested)
- container sizes: 500 / 1.000 ml
- stainless steel container: 450 ml
- repair kit big / small
- complete interior set
- press button
- fastening set
- bottle nut with valve
- hexagon spanner: 3 mm
- hose line
- bottom valve / hose extension kit
- filling funnel
- fixing for 5 litre-container (stainless steel)
- washer  $\varnothing$  50 mm,  
drilling diameter: 21-35 mm
- washer  $\varnothing$  60 mm,  
drilling diameter: 21-35 mm

### Proposal for tender offer:

Table soap dispenser, brass chromium plated,  
burglar-proof, to be filled from the top, for the  
installation in washing stands. With soap dish,  
content 500 ml / 1.000 ml.

Outlet: 90 mm

### Item No.

12404031 / Seifomat® Universal Knopf  
Exquisit 404/03/10

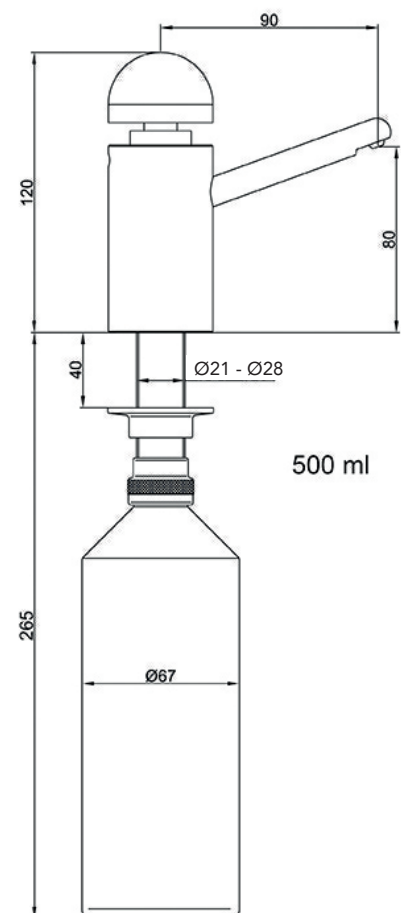

Fritz Ostermann GmbH

Gottlieb-Daimler-Str. 24  
59439 Holzwickede

Fon +49 (0) 2301-91940-0  
Fax +49 (0) 2301-91940-20

info@seifomat.de  
www.seifomat.de